

10247154

2650±20

2760±20

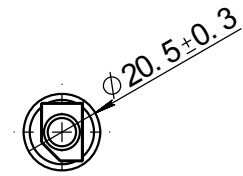
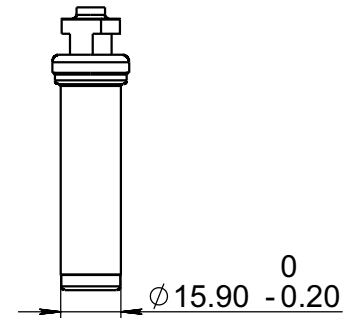
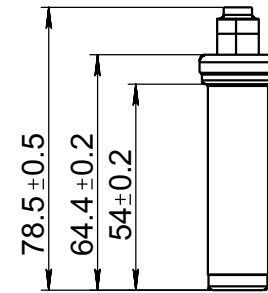
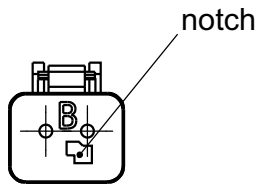
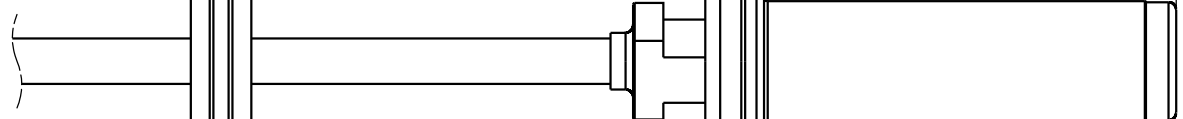
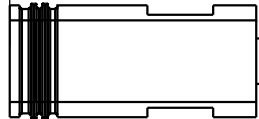
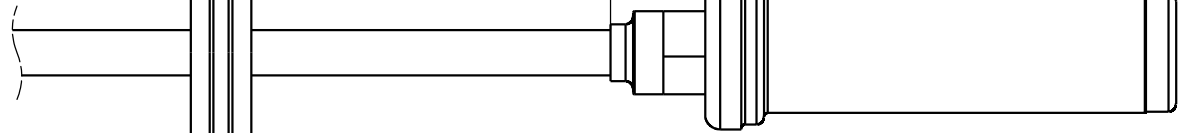
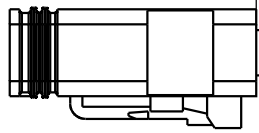

10247154

Rev.	Sheet	Doc. No.	Sign.	Date
Dvlpd by				
Chkd by				
Tech. Ctrl				
Reg. Ctrl				
Aprvd by				

ABS sensor

PA66 reinforced nylon
(black) + GF30

Letter	Weight	Scale
		1:1
Sheet	Sheets 1	