

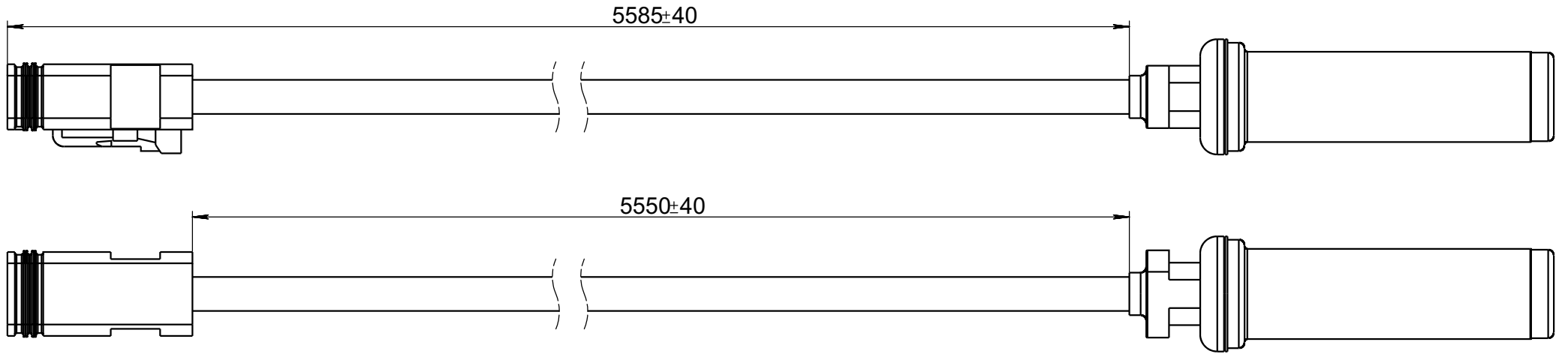

10323490

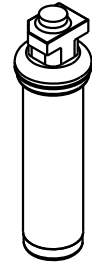

notch

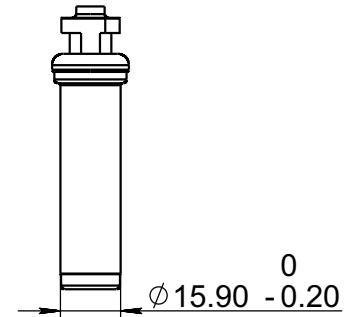
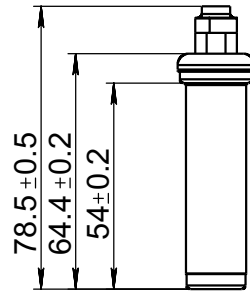
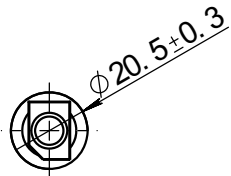
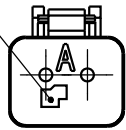

|   |       |          |       |      |  |        |       |   |  |   |  |  |  |  |  |  |  |   |   |  |     |     |  |  |  |  |  |   |  |  |     |  |     |  |  |  |  |  |  |  |  |   |  |  |     |  |  |  |  |  |  |   |  |  |     |  |     |  |  |  |  |  |  |   |  |  |     |  |  |  |  |  |  |   |  |  |     |  |
|---|-------|----------|-------|------|--|--------|-------|---|--|---|--|--|--|--|--|--|--|---|---|--|-----|-----|--|--|--|--|--|---|--|--|-----|--|-----|--|--|--|--|--|--|--|--|---|--|--|-----|--|--|--|--|--|--|---|--|--|-----|--|-----|--|--|--|--|--|--|---|--|--|-----|--|--|--|--|--|--|---|--|--|-----|--|
|    |       |          |       |      | <h1 style="text-align: center;">10323490</h1>  |        |       |   |  |   |  |  |  |  |  |  |  |   |   |  |     |     |  |  |  |  |  |   |  |  |     |  |     |  |  |  |  |  |  |  |  |   |  |  |     |  |  |  |  |  |  |   |  |  |     |  |     |  |  |  |  |  |  |   |  |  |     |  |  |  |  |  |  |   |  |  |     |  |
|   |       |          |       |      |  |        |       | <h2 style="text-align: center;">ABS sensor</h2> |  |   |  |  |  |  |  |  |  |   |   |  |     |     |  |  |  |  |  |   |  |  |     |  |     |  |  |  |  |  |  |  |  |   |  |  |     |  |  |  |  |  |  |   |  |  |     |  |     |  |  |  |  |  |  |   |  |  |     |  |  |  |  |  |  |   |  |  |     |  |
| Rev.  | Sheet | Doc. No. | Sign. | Date | Letter   | Weight | Scale |   |  |   |  |  |  |  |  |  |  |   |   |  |     |     |  |  |  |  |  |   |  |  |     |  |     |  |  |  |  |  |  |  |  |   |  |  |     |  |  |  |  |  |  |   |  |  |     |  |     |  |  |  |  |  |  |   |  |  |     |  |  |  |  |  |  |   |  |  |     |  |
| <table border="1" style="width: 100%; border-collapse: collapse;"> <tr> <td style="width: 20px; height: 20px;"></td> <td style="width: 20px; height: 20px;"></td> <td style="width: 20px; height: 20px;"></td> <td style="width: 20px; height: 20px;"></td> <td style="width: 20px; height: 20px;"></td> <td style="width: 20px; height: 20px;"></td> <td style="width: 20px; height: 20px;"></td> <td style="width: 20px; height: 20px;"></td> <td style="width: 20px; height: 20px;"></td> </tr> <tr> <td colspan="5" rowspan="2"> <table border="1" style="width: 100%; border-collapse: collapse;"> <tr> <td colspan="3" style="text-align: center;">PA66 reinforced nylon<br/>(black) + GF30</td> </tr> </table> </td> <td colspan="2" style="text-align: center;">1:1</td> </tr> <tr> <td colspan="5" rowspan="2"> <table border="1" style="width: 100%; border-collapse: collapse;"> <tr> <td style="width: 20px; height: 20px;"></td> <td style="width: 20px; height: 20px;"></td> <td style="width: 20px; height: 20px;"></td> <td style="width: 20px; height: 20px;"></td> <td style="width: 20px; height: 20px;"></td> <td style="width: 20px; height: 20px;"></td> <td style="width: 20px; height: 20px;"></td> <td style="width: 20px; height: 20px;"></td> </tr> <tr> <td colspan="5" rowspan="2"> <table border="1" style="width: 100%; border-collapse: collapse;"> <tr> <td colspan="3" style="text-align: center;">PA66 reinforced nylon<br/>(black) + GF30</td> </tr> </table> </td> <td colspan="2" style="text-align: center;">1:1</td> </tr> <tr> <td colspan="5" rowspan="2"> <table border="1" style="width: 100%; border-collapse: collapse;"> <tr> <td colspan="3" style="text-align: center;">PA66 reinforced nylon<br/>(black) + GF30</td> </tr> </table> </td> <td colspan="2" style="text-align: center;">1:1</td> </tr> </table> </td> <td colspan="2" style="text-align: center;">1:1</td> </tr> <tr> <td colspan="5" rowspan="2"> <table border="1" style="width: 100%; border-collapse: collapse;"> <tr> <td colspan="3" style="text-align: center;">PA66 reinforced nylon<br/>(black) + GF30</td> </tr> </table> </td> <td colspan="2" style="text-align: center;">1:1</td> </tr> <tr> <td colspan="5" rowspan="2"> <table border="1" style="width: 100%; border-collapse: collapse;"> <tr> <td colspan="3" style="text-align: center;">PA66 reinforced nylon<br/>(black) + GF30</td> </tr> </table> </td> <td colspan="2" style="text-align: center;">1:1</td> </tr> </table> |       |          |       |      |  |        |       |   |  |   |  |  |  | <table border="1" style="width: 100%; border-collapse: collapse;"> <tr> <td colspan="3" style="text-align: center;">PA66 reinforced nylon<br/>(black) + GF30</td> </tr> </table> |  |  |  |   | PA66 reinforced nylon<br>(black) + GF30 |  |     | 1:1 |  | <table border="1" style="width: 100%; border-collapse: collapse;"> <tr> <td style="width: 20px; height: 20px;"></td> <td style="width: 20px; height: 20px;"></td> <td style="width: 20px; height: 20px;"></td> <td style="width: 20px; height: 20px;"></td> <td style="width: 20px; height: 20px;"></td> <td style="width: 20px; height: 20px;"></td> <td style="width: 20px; height: 20px;"></td> <td style="width: 20px; height: 20px;"></td> </tr> <tr> <td colspan="5" rowspan="2"> <table border="1" style="width: 100%; border-collapse: collapse;"> <tr> <td colspan="3" style="text-align: center;">PA66 reinforced nylon<br/>(black) + GF30</td> </tr> </table> </td> <td colspan="2" style="text-align: center;">1:1</td> </tr> <tr> <td colspan="5" rowspan="2"> <table border="1" style="width: 100%; border-collapse: collapse;"> <tr> <td colspan="3" style="text-align: center;">PA66 reinforced nylon<br/>(black) + GF30</td> </tr> </table> </td> <td colspan="2" style="text-align: center;">1:1</td> </tr> </table> |  |  |  |   |  |  |     |  |     |  |  |  | <table border="1" style="width: 100%; border-collapse: collapse;"> <tr> <td colspan="3" style="text-align: center;">PA66 reinforced nylon<br/>(black) + GF30</td> </tr> </table> |  |  |  |  | PA66 reinforced nylon<br>(black) + GF30 |  |  | 1:1 |  | <table border="1" style="width: 100%; border-collapse: collapse;"> <tr> <td colspan="3" style="text-align: center;">PA66 reinforced nylon<br/>(black) + GF30</td> </tr> </table> |  |  |  |  | PA66 reinforced nylon<br>(black) + GF30 |  |  | 1:1 |  | 1:1 |  | <table border="1" style="width: 100%; border-collapse: collapse;"> <tr> <td colspan="3" style="text-align: center;">PA66 reinforced nylon<br/>(black) + GF30</td> </tr> </table> |  |  |  |  | PA66 reinforced nylon<br>(black) + GF30 |  |  | 1:1 |  | <table border="1" style="width: 100%; border-collapse: collapse;"> <tr> <td colspan="3" style="text-align: center;">PA66 reinforced nylon<br/>(black) + GF30</td> </tr> </table> |  |  |  |  | PA66 reinforced nylon<br>(black) + GF30 |  |  | 1:1 |  |
|   |       |          |       |      |  |        |       |   |  |   |  |  |  |  |  |  |  |   |   |  |     |     |  |  |  |  |  |   |  |  |     |  |     |  |  |  |  |  |  |  |  |   |  |  |     |  |  |  |  |  |  |   |  |  |     |  |     |  |  |  |  |  |  |   |  |  |     |  |  |  |  |  |  |   |  |  |     |  |
|   |       |          |       |      | <table border="1" style="width: 100%; border-collapse: collapse;"> <tr> <td colspan="3" style="text-align: center;">PA66 reinforced nylon<br/>(black) + GF30</td> </tr> </table> |        |       |   |  | PA66 reinforced nylon<br>(black) + GF30 |  |  | 1:1  |  |  |  |  |   |   |  |     |     |  |  |  |  |  |   |  |  |     |  |     |  |  |  |  |  |  |  |  |   |  |  |     |  |  |  |  |  |  |   |  |  |     |  |     |  |  |  |  |  |  |   |  |  |     |  |  |  |  |  |  |   |  |  |     |  |
| PA66 reinforced nylon<br>(black) + GF30   |       |          |       |      |  |        |       |   |  |   |  |  |  |  |  |  |  |   |   |  |     |     |  |  |  |  |  |   |  |  |     |  |     |  |  |  |  |  |  |  |  |   |  |  |     |  |  |  |  |  |  |   |  |  |     |  |     |  |  |  |  |  |  |   |  |  |     |  |  |  |  |  |  |   |  |  |     |  |
| <table border="1" style="width: 100%; border-collapse: collapse;"> <tr> <td style="width: 20px; height: 20px;"></td> <td style="width: 20px; height: 20px;"></td> <td style="width: 20px; height: 20px;"></td> <td style="width: 20px; height: 20px;"></td> <td style="width: 20px; height: 20px;"></td> <td style="width: 20px; height: 20px;"></td> <td style="width: 20px; height: 20px;"></td> <td style="width: 20px; height: 20px;"></td> </tr> <tr> <td colspan="5" rowspan="2"> <table border="1" style="width: 100%; border-collapse: collapse;"> <tr> <td colspan="3" style="text-align: center;">PA66 reinforced nylon<br/>(black) + GF30</td> </tr> </table> </td> <td colspan="2" style="text-align: center;">1:1</td> </tr> <tr> <td colspan="5" rowspan="2"> <table border="1" style="width: 100%; border-collapse: collapse;"> <tr> <td colspan="3" style="text-align: center;">PA66 reinforced nylon<br/>(black) + GF30</td> </tr> </table> </td> <td colspan="2" style="text-align: center;">1:1</td> </tr> </table>  |       |          |       |      |  |        |       |   |  |   |  |  | <table border="1" style="width: 100%; border-collapse: collapse;"> <tr> <td colspan="3" style="text-align: center;">PA66 reinforced nylon<br/>(black) + GF30</td> </tr> </table> |  |  |  |  | PA66 reinforced nylon<br>(black) + GF30 |   |  | 1:1 |     | <table border="1" style="width: 100%; border-collapse: collapse;"> <tr> <td colspan="3" style="text-align: center;">PA66 reinforced nylon<br/>(black) + GF30</td> </tr> </table> |  |  |  |  | PA66 reinforced nylon<br>(black) + GF30 |  |  | 1:1 |  | 1:1 |  |  |  |  |  |  |  |  |   |  |  |     |  |  |  |  |  |  |   |  |  |     |  |     |  |  |  |  |  |  |   |  |  |     |  |  |  |  |  |  |   |  |  |     |  |
|   |       |          |       |      |  |        |       |   |  |   |  |  |  |  |  |  |  |   |   |  |     |     |  |  |  |  |  |   |  |  |     |  |     |  |  |  |  |  |  |  |  |   |  |  |     |  |  |  |  |  |  |   |  |  |     |  |     |  |  |  |  |  |  |   |  |  |     |  |  |  |  |  |  |   |  |  |     |  |
| <table border="1" style="width: 100%; border-collapse: collapse;"> <tr> <td colspan="3" style="text-align: center;">PA66 reinforced nylon<br/>(black) + GF30</td> </tr> </table>  |       |          |       |      | PA66 reinforced nylon<br>(black) + GF30  |        |       | 1:1   |  |   |  |  |  |  |  |  |  |   |   |  |     |     |  |  |  |  |  |   |  |  |     |  |     |  |  |  |  |  |  |  |  |   |  |  |     |  |  |  |  |  |  |   |  |  |     |  |     |  |  |  |  |  |  |   |  |  |     |  |  |  |  |  |  |   |  |  |     |  |
|   |       |          |       |      | PA66 reinforced nylon<br>(black) + GF30  |        |       |   |  |   |  |  |  |  |  |  |  |   |   |  |     |     |  |  |  |  |  |   |  |  |     |  |     |  |  |  |  |  |  |  |  |   |  |  |     |  |  |  |  |  |  |   |  |  |     |  |     |  |  |  |  |  |  |   |  |  |     |  |  |  |  |  |  |   |  |  |     |  |
| <table border="1" style="width: 100%; border-collapse: collapse;"> <tr> <td colspan="3" style="text-align: center;">PA66 reinforced nylon<br/>(black) + GF30</td> </tr> </table>  |       |          |       |      | PA66 reinforced nylon<br>(black) + GF30  |        |       | 1:1   |  |   |  |  |  |  |  |  |  |   |   |  |     |     |  |  |  |  |  |   |  |  |     |  |     |  |  |  |  |  |  |  |  |   |  |  |     |  |  |  |  |  |  |   |  |  |     |  |     |  |  |  |  |  |  |   |  |  |     |  |  |  |  |  |  |   |  |  |     |  |
|   |       |          |       |      | PA66 reinforced nylon<br>(black) + GF30  |        |       |   |  |   |  |  |  |  |  |  |  |   |   |  |     |     |  |  |  |  |  |   |  |  |     |  |     |  |  |  |  |  |  |  |  |   |  |  |     |  |  |  |  |  |  |   |  |  |     |  |     |  |  |  |  |  |  |   |  |  |     |  |  |  |  |  |  |   |  |  |     |  |
| <table border="1" style="width: 100%; border-collapse: collapse;"> <tr> <td colspan="3" style="text-align: center;">PA66 reinforced nylon<br/>(black) + GF30</td> </tr> </table>  |       |          |       |      | PA66 reinforced nylon<br>(black) + GF30  |        |       | 1:1   |  |   |  |  |  |  |  |  |  |   |   |  |     |     |  |  |  |  |  |   |  |  |     |  |     |  |  |  |  |  |  |  |  |   |  |  |     |  |  |  |  |  |  |   |  |  |     |  |     |  |  |  |  |  |  |   |  |  |     |  |  |  |  |  |  |   |  |  |     |  |
|   |       |          |       |      | PA66 reinforced nylon<br>(black) + GF30  |        |       |   |  |   |  |  |  |  |  |  |  |   |   |  |     |     |  |  |  |  |  |   |  |  |     |  |     |  |  |  |  |  |  |  |  |   |  |  |     |  |  |  |  |  |  |   |  |  |     |  |     |  |  |  |  |  |  |   |  |  |     |  |  |  |  |  |  |   |  |  |     |  |
| <table border="1" style="width: 100%; border-collapse: collapse;"> <tr> <td colspan="3" style="text-align: center;">PA66 reinforced nylon<br/>(black) + GF30</td> </tr> </table>  |       |          |       |      | PA66 reinforced nylon<br>(black) + GF30  |        |       | 1:1   |  |   |  |  |  |  |  |  |  |   |   |  |     |     |  |  |  |  |  |   |  |  |     |  |     |  |  |  |  |  |  |  |  |   |  |  |     |  |  |  |  |  |  |   |  |  |     |  |     |  |  |  |  |  |  |   |  |  |     |  |  |  |  |  |  |   |  |  |     |  |
|   |       |          |       |      | PA66 reinforced nylon<br>(black) + GF30  |        |       |   |  |   |  |  |  |  |  |  |  |   |   |  |     |     |  |  |  |  |  |   |  |  |     |  |     |  |  |  |  |  |  |  |  |   |  |  |     |  |  |  |  |  |  |   |  |  |     |  |     |  |  |  |  |  |  |   |  |  |     |  |  |  |  |  |  |   |  |  |     |  |