

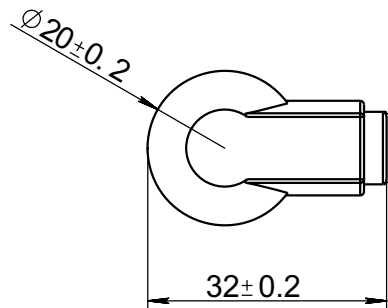

10327280

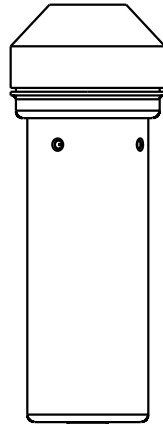
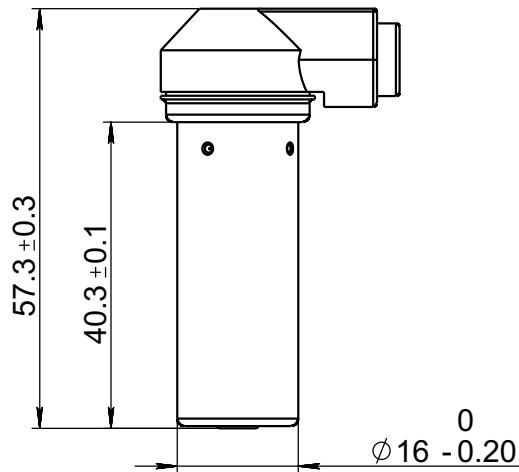
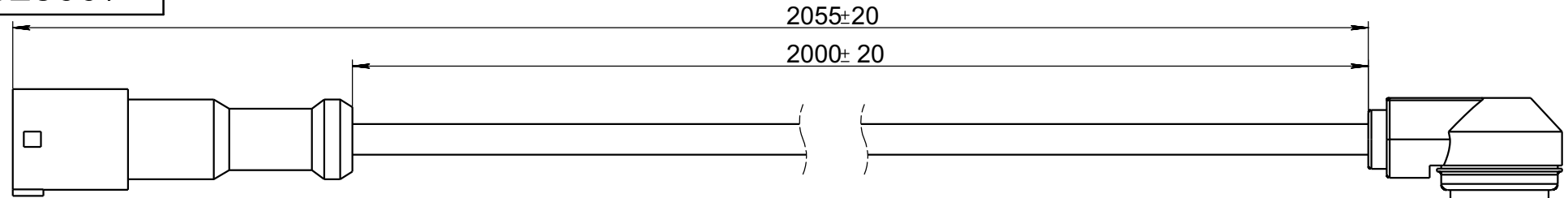

					<h1>10327280</h1>		
Rev.	Sheet	Doc. No.	Sign.	Date	Letter	Weight	Scale
Dvlpd by							1:1
Chkd by							
Tech. Ctrl					Sheet	Sheets 1	
Reg. Ctrl					PA66 reinforced nylon (black) + GF30		
Aprvd by							