

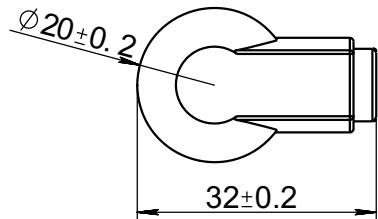

10328790

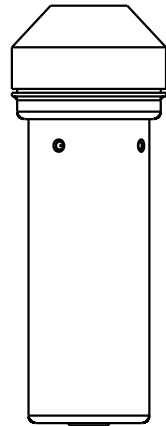
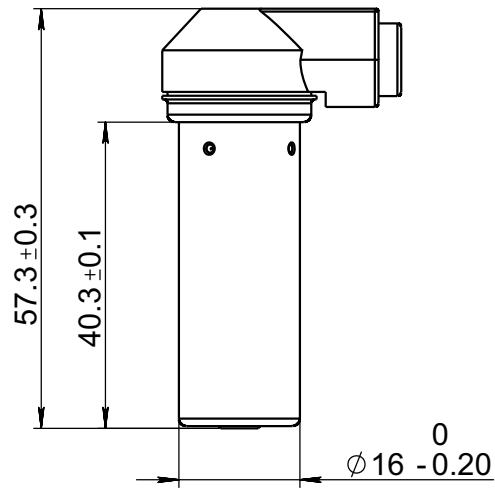
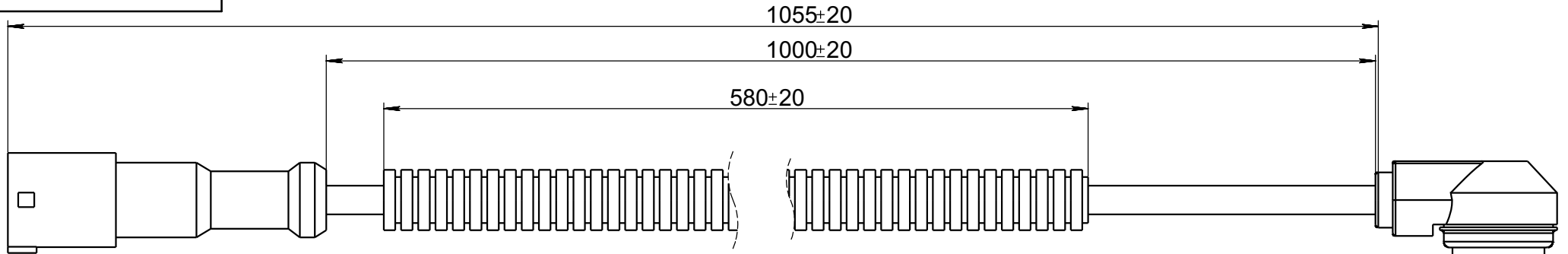

					<h1>10328790</h1>		
Rev.	Sheet	Doc. No.	Sign.	Date	Letter	Weight	Scale
							1:1
Dvlpd by					Sheet		
Chkd by					Sheets 1		
Tech. Ctrl							
Reg. Ctrl					PA66 reinforced nylon (black) + GF30		
Aprvd by							