

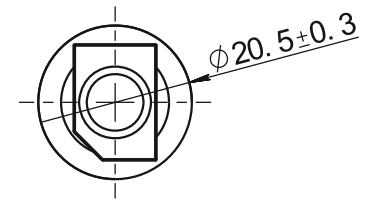

10353440

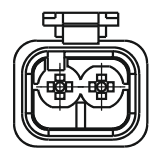
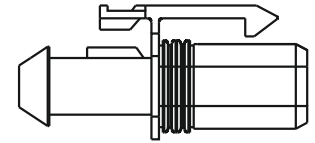
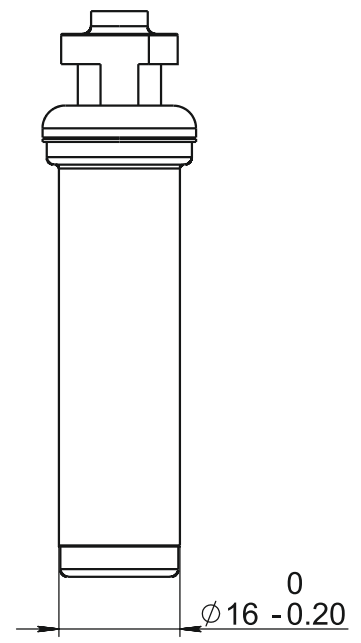
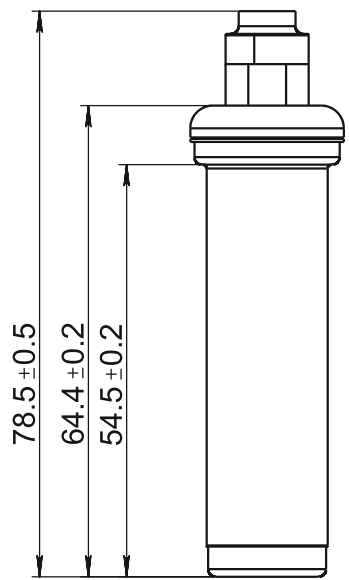
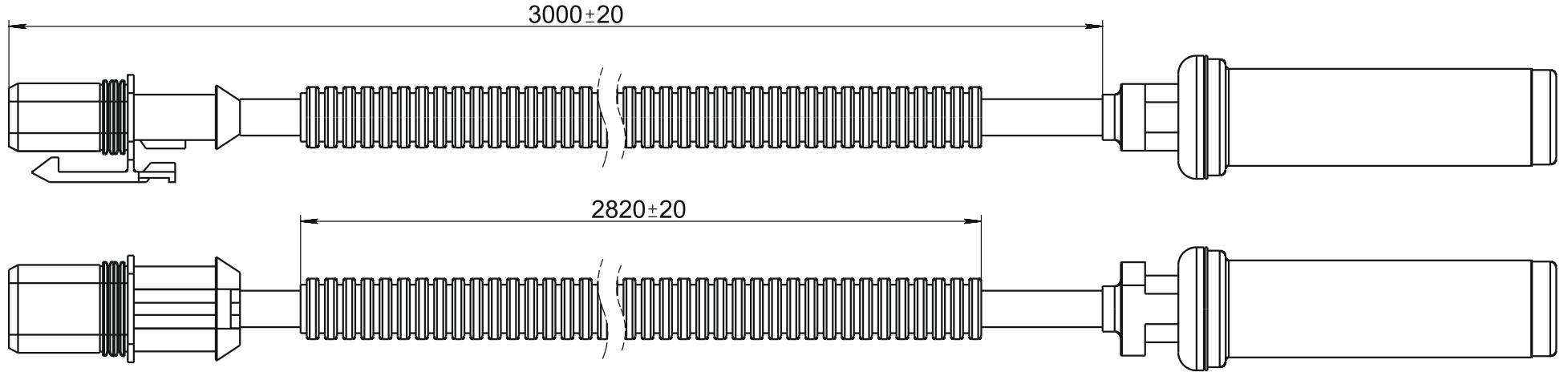

					<h1 style="text-align: center;">10353440</h1>		
Rev. Sheet	Doc. No.	Sign.	Date	Letter	Weight	Scale	
Dvlpd by							1:1
Chkd by							
Tech. Ctrl							
Reg. Ctrl							
Aprvd by							
PA66 reinforced nylon (black) + GF30					Sheet	Sheets 1	