

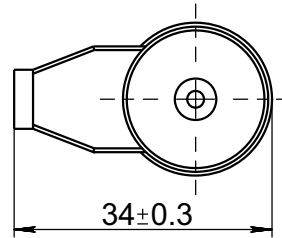

10306202

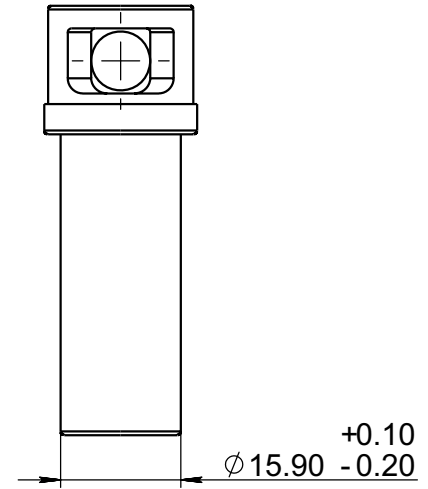
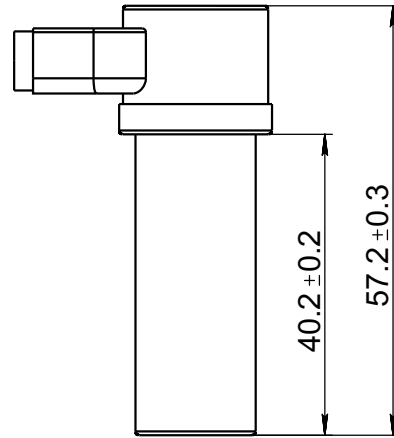
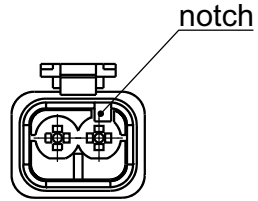
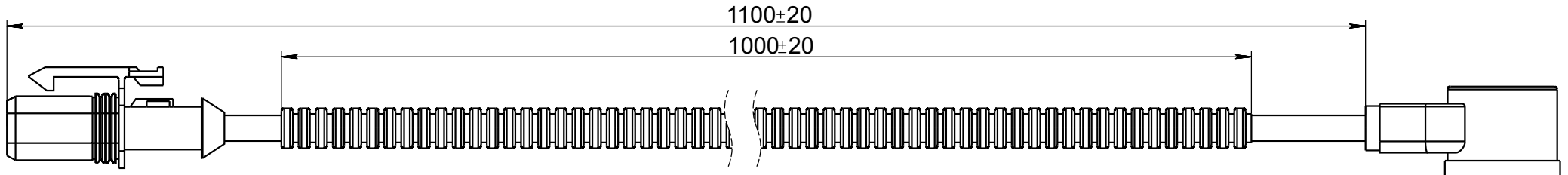

					<h1 style="text-align: center;">10306202</h1>							
								<h2 style="text-align: center;">ABS sensor</h2>				
Rev.	Sheet	Doc. No.	Sign.	Date	Letter	Weight	Scale					
Dvlpd by Chkd by Tech. Ctrl					1:1							
								Reg. Ctrl		Sheet		Sheets 1
								Aprvd by				
					PA66 reinforced nylon (black) + GF30							