

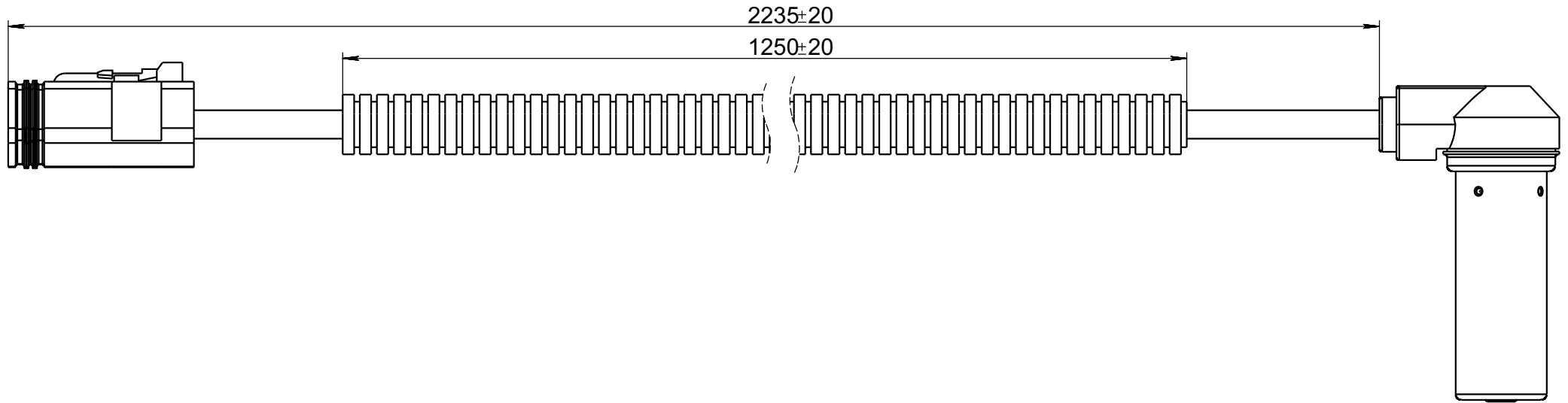

10321150

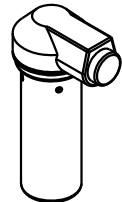

notch

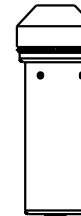
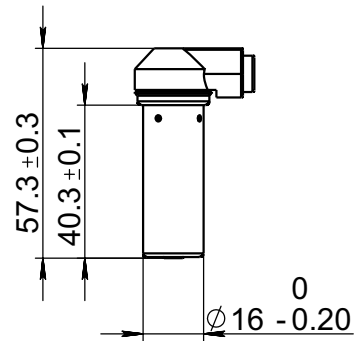
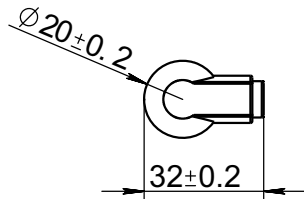
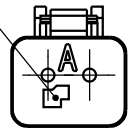

					<h1 style="text-align: center;">10321150</h1>			
								<h2 style="text-align: center;">ABS sensor</h2>
Rev.	Sheet	Doc. No.	Sign.	Date	Letter	Weight	Scale	
								1:1
PA66 reinforced nylon (black) + GF30						Sheet	Sheets 1	