

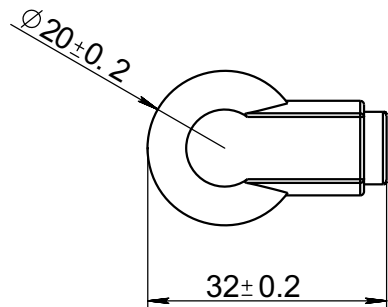

10327280

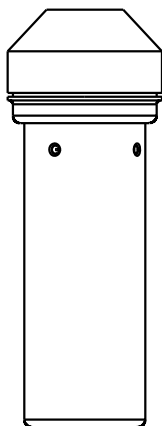
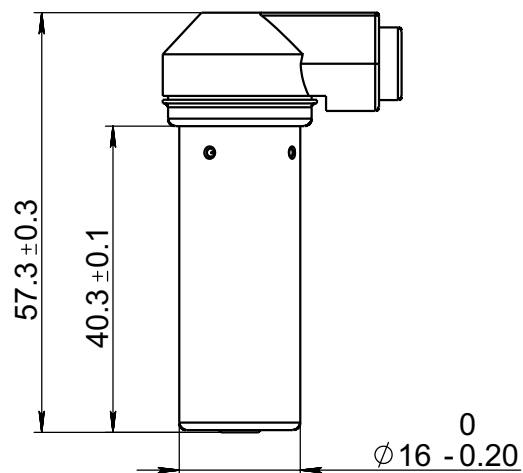
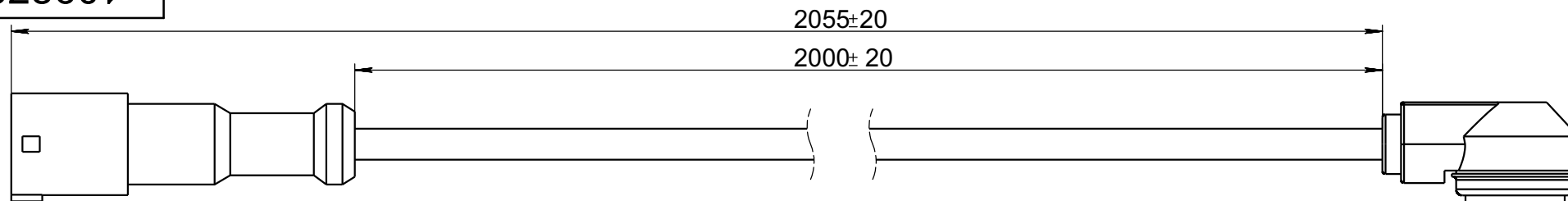

					<h1>10327280</h1>		
Изм.	Лист	№. докум.	Подп.	Дата	Лит.	Масса	Масштаб
Разраб.							1:1
Пров.							
Т. контр.					Лист	Листов	1
Н. контр.					PA66 армированный нейлон (черный) + GF30		
Утв.							