

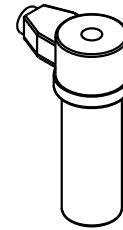

10457300

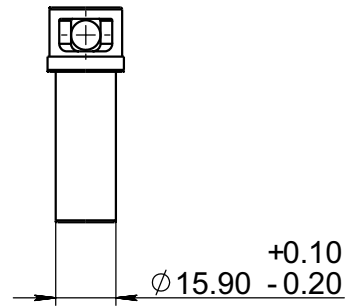
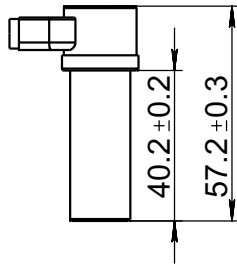
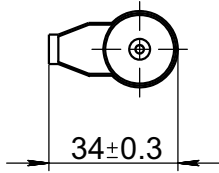
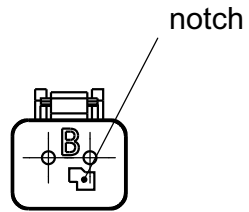
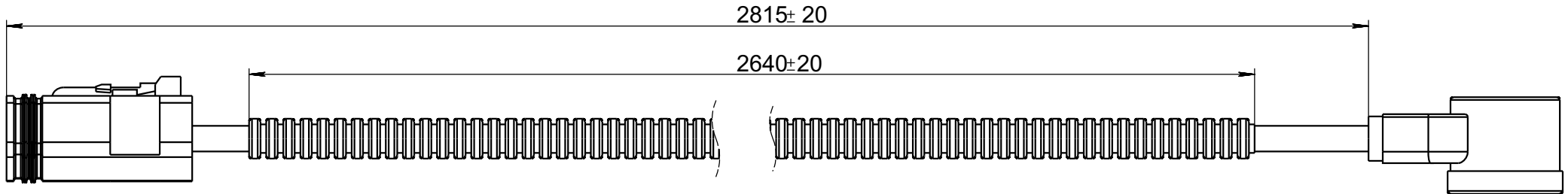

					<p>10457300</p>		
Rev.	Sheet	Doc. No.	Sign.	Date	Letter	Weight	Scale
							1:1
<p>Dvlpd by</p> <p>Chkd by</p> <p>Tech. Ctrl</p>					<p>Sheet</p>		<p>Sheets 1</p>
<p>Reg. Ctrl</p> <p>Aprvd by</p>					<p>PA66 reinforced nylon (black) + GF30</p>		